

3D
1:25

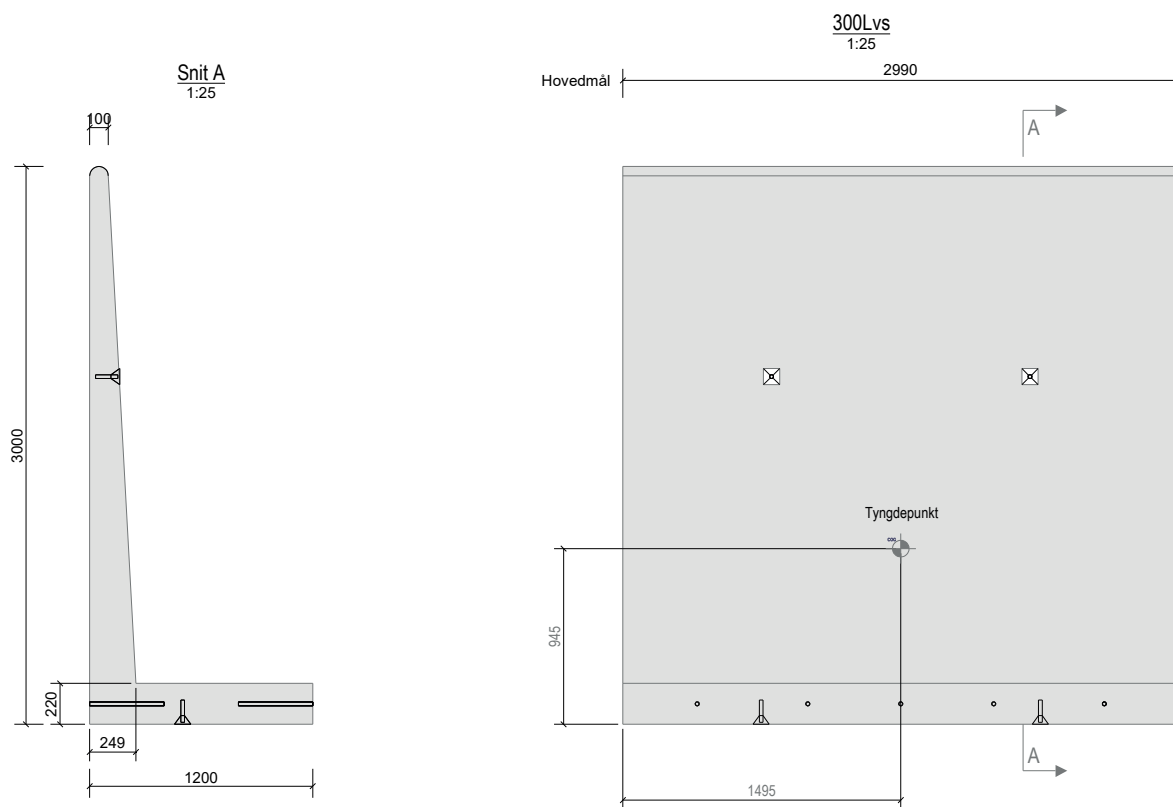

Type	L (mm)	H (mm)	B (mm)	Kg (ca.)	Miljøklasse	Løftegrej
Standard	2.990	3.000	1.500	5.600	Aggressiv	5,0 t. kugle-hoved løft
Hjørne (h)	2.970	3.000	1.500	4.800	Aggressiv	5,0 t. kugle-hoved løft
Hjørne (v)	2.970	3.000	1.500	4.800	Aggressiv	5,0 t. kugle-hoved løft
1 meters pas	990	3.000	1.500	1.870	Aggressiv	5,0 t. kugle-hoved løft
2 meters pas	1.990	3.000	1.500	3.750	Aggressiv	5,0 t. kugle-hoved løft

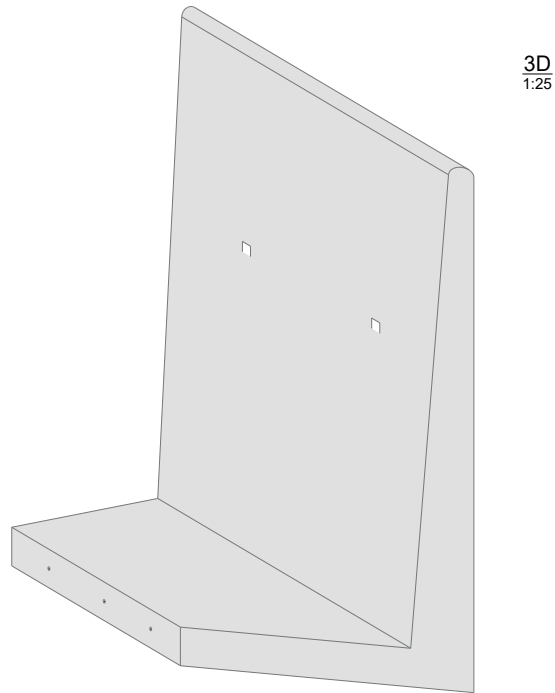

Type	L (mm)	H (mm)	B (mm)	Kg (ca.)	Miljøklasse	Løftegrej
Standard	2.990	3.000	1.500	5.600	Aggressiv	5,0 t. kugle-hoved løft
Hjørne (h)	2.970	3.000	1.500	4.800	Aggressiv	5,0 t. kugle-hoved løft
Hjørne (v)	2.970	3.000	1.500	4.800	Aggressiv	5,0 t. kugle-hoved løft
1 meters pas	990	3.000	1.500	1.870	Aggressiv	5,0 t. kugle-hoved løft
2 meters pas	1.990	3.000	1.500	3.750	Aggressiv	5,0 t. kugle-hoved løft

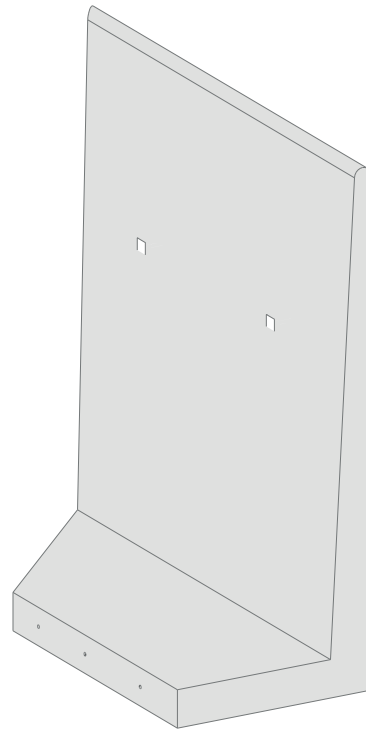

3D
1:25

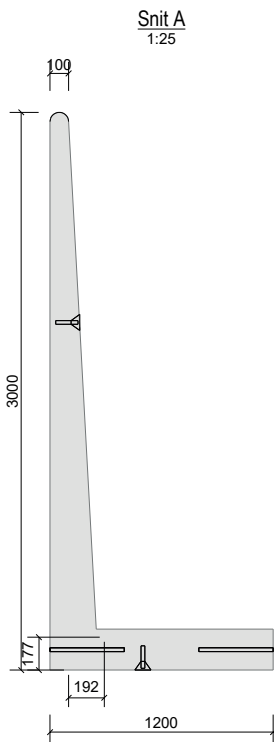

Snit A
1:25

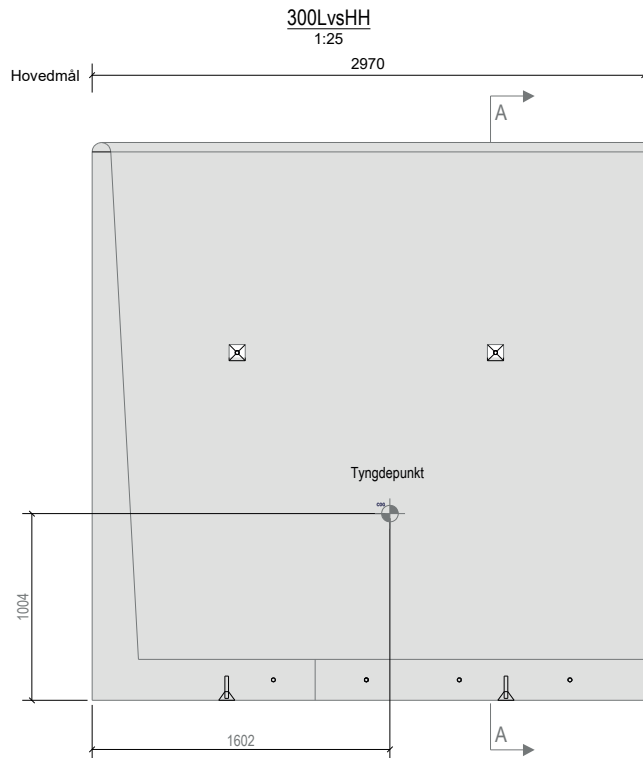

300LvsHH
1:25

Type	L (mm)	H (mm)	B (mm)	Kg (ca.)	Miljøklasse	Løftegrej
Standard	2.990	3.000	1.500	5.600	Aggressiv	5,0 t. kugle-hoved løft
Hjørne (h)	2.970	3.000	1.500	4.800	Aggressiv	5,0 t. kugle-hoved løft
Hjørne (v)	2.970	3.000	1.500	4.800	Aggressiv	5,0 t. kugle-hoved løft
1 meters pas	990	3.000	1.500	1.870	Aggressiv	5,0 t. kugle-hoved løft
2 meters pas	1.990	3.000	1.500	3.750	Aggressiv	5,0 t. kugle-hoved løft

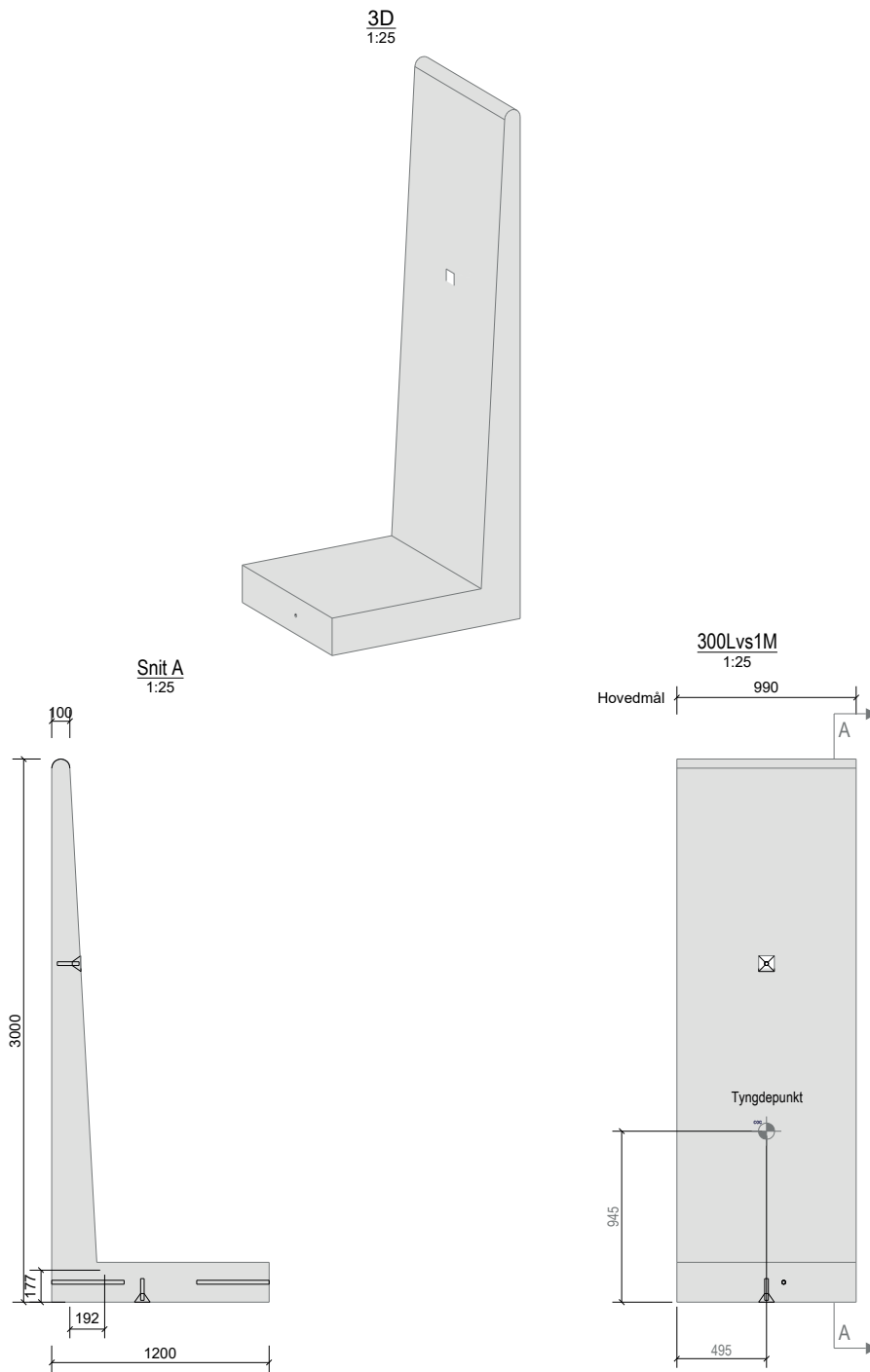

Type	L (mm)	H (mm)	B (mm)	Kg (ca.)	Miljøklasse	Løftegrej
Standard	2.990	3.000	1.500	5.600	Aggressiv	5,0 t. kugle-hoved løft
Hjørne (h)	2.970	3.000	1.500	4.800	Aggressiv	5,0 t. kugle-hoved løft
Hjørne (v)	2.970	3.000	1.500	4.800	Aggressiv	5,0 t. kugle-hoved løft
1 meters pas	990	3.000	1.500	1.870	Aggressiv	5,0 t. kugle-hoved løft
2 meters pas	1.990	3.000	1.500	3.750	Aggressiv	5,0 t. kugle-hoved løft

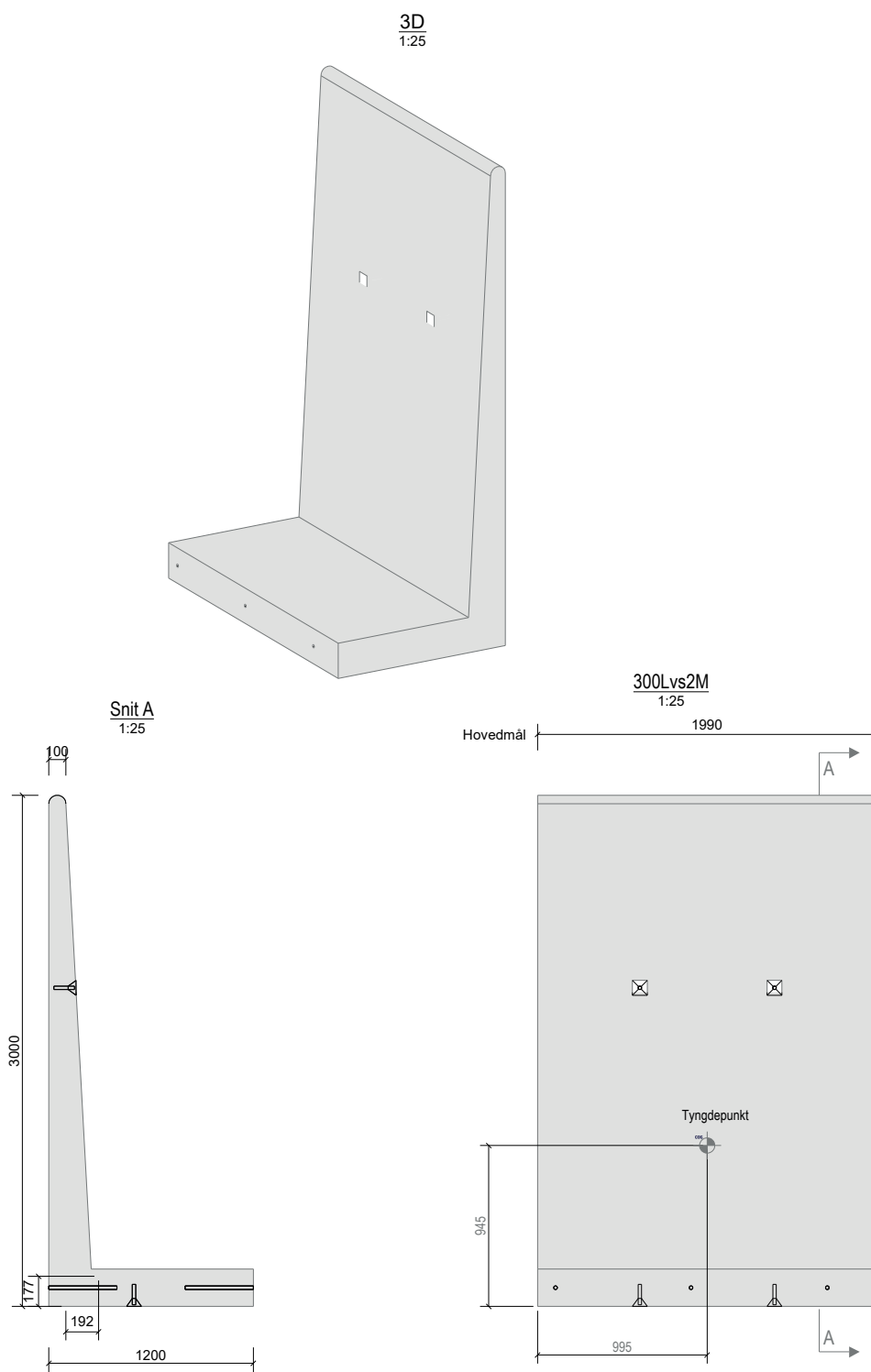

Type	L (mm)	H (mm)	B (mm)	Kg (ca.)	Miljøklasse	Løftegrej
Standard	2.990	3.000	1.500	5.600	Aggressiv	5,0 t. kugle-hoved løft
Hjørne (h)	2.970	3.000	1.500	4.800	Aggressiv	5,0 t. kugle-hoved løft
Hjørne (v)	2.970	3.000	1.500	4.800	Aggressiv	5,0 t. kugle-hoved løft
1 meters pas	990	3.000	1.500	1.870	Aggressiv	5,0 t. kugle-hoved løft
2 meters pas	1.990	3.000	1.500	3.750	Aggressiv	5,0 t. kugle-hoved løft

300L Plan

Hjørnesamling

