

3D

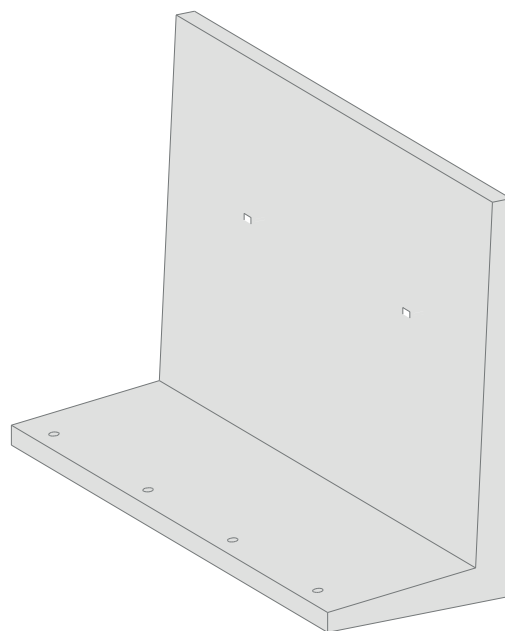

Snit A

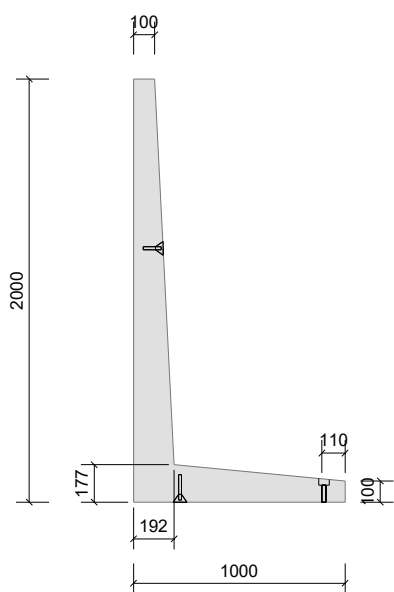

Opstalt

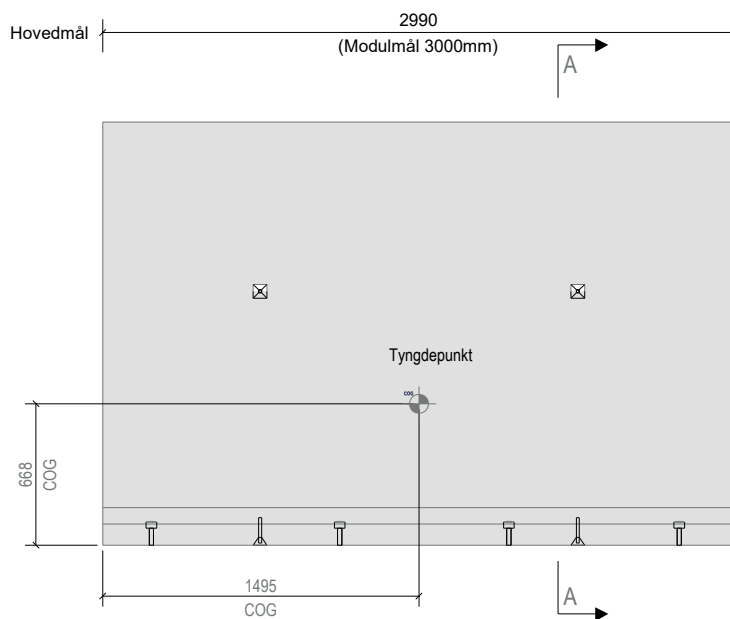

Type	L (mm)	H (mm)	B (mm)	Kg (ca.)	Miljøklasse	Løftegrej	Fladelast
Standard	2.990	2.000	1.000	2.960	Aggressiv	2,5 t. kuglehoved løft	5 kN/m <sup>2</sup>
Hjørne (h)	2.970	2.000	1.000	2.810	Aggressiv	2,5 t. kuglehoved løft	5 kN/m <sup>2</sup>
Hjørne (v)	2.970	2.000	1.000	2.810	Aggressiv	2,5 t. kuglehoved løft	5 kN/m <sup>2</sup>
1 meters pas	990	2.000	1.000	990	Aggressiv	2,5 t. kuglehoved løft	5 kN/m <sup>2</sup>
2 meters pas	1.990	2.000	1.000	1.980	Aggressiv	2,5 t. kuglehoved løft	5 kN/m <sup>2</sup>

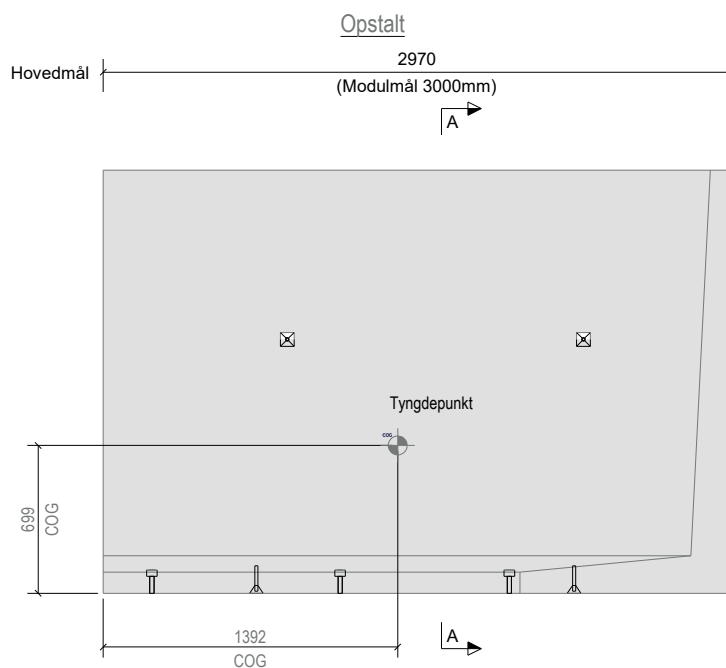
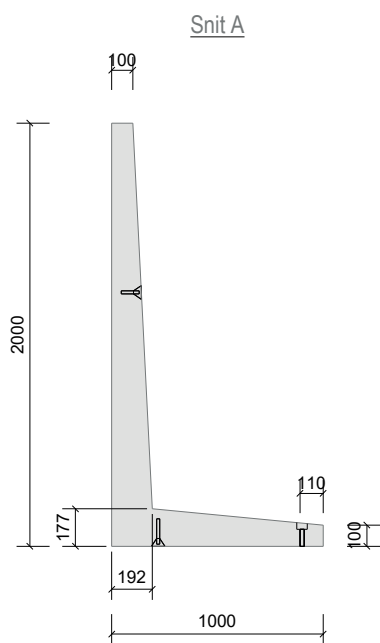
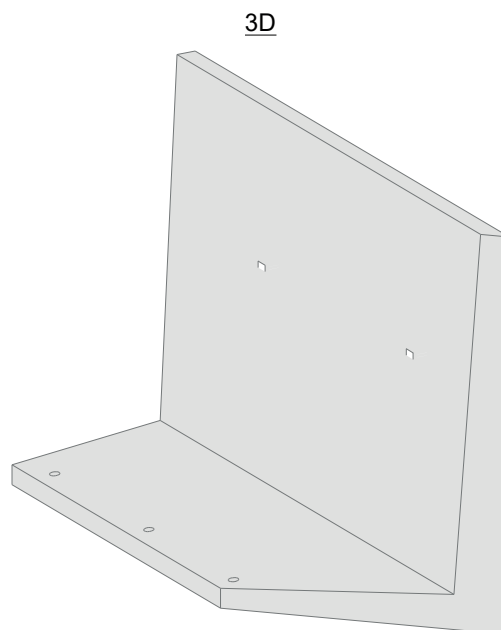

Type	L (mm)	H (mm)	B (mm)	Kg (ca.)	Miljøklasse	Løftegrej	Fladelast
Standard	2.990	2.000	1.000	2.960	Aggressiv	2,5 t. kuglehoved løft	5 kN/m <sup>2</sup>
Hjørne (h)	2.970	2.000	1.000	2.810	Aggressiv	2,5 t. kuglehoved løft	5 kN/m <sup>2</sup>
Hjørne (v)	2.970	2.000	1.000	2.810	Aggressiv	2,5 t. kuglehoved løft	5 kN/m <sup>2</sup>
1 meters pas	990	2.000	1.000	990	Aggressiv	2,5 t. kuglehoved løft	5 kN/m <sup>2</sup>
2 meters pas	1.990	2.000	1.000	1.980	Aggressiv	2,5 t. kuglehoved løft	5 kN/m <sup>2</sup>

3D

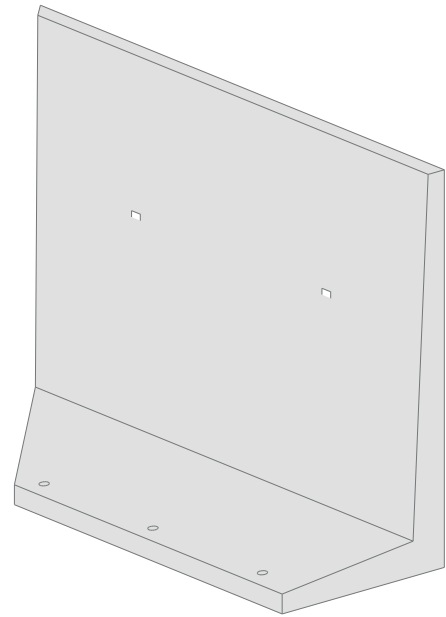

Snit A

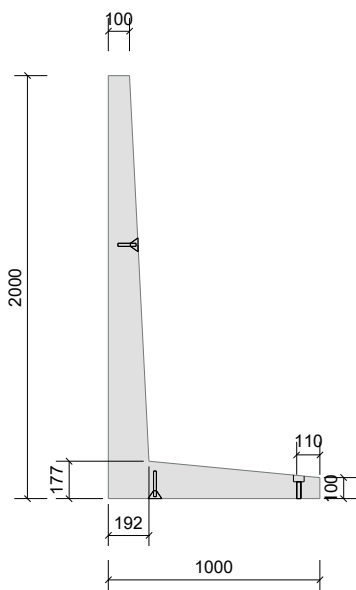

Opstalt

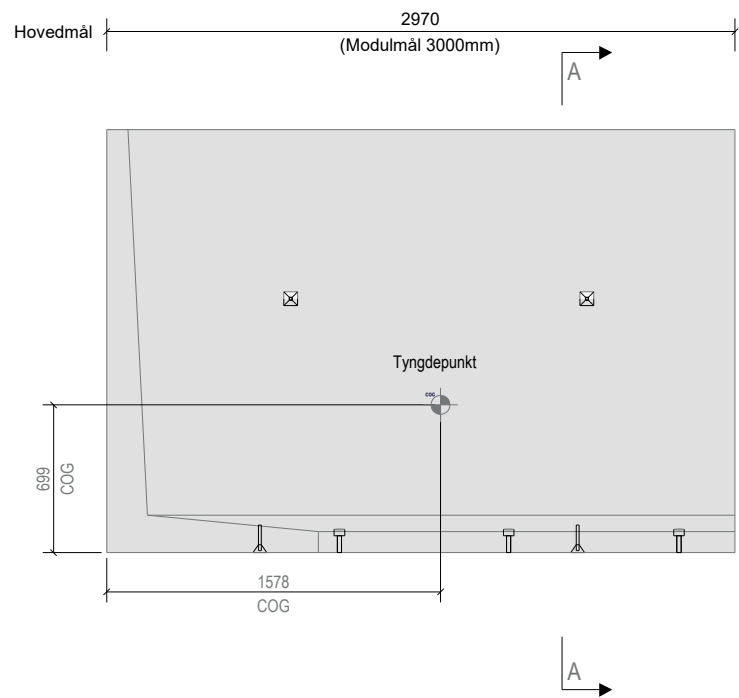

Type	L (mm)	H (mm)	B (mm)	Kg (ca.)	Miljøklasse	Løftegrej	Fladelast
Standard	2.990	2.000	1.000	2.960	Aggressiv	2,5 t. kuglehoved løft	5 kN/m <sup>2</sup>
Hjørne (h)	2.970	2.000	1.000	2.810	Aggressiv	2,5 t. kuglehoved løft	5 kN/m <sup>2</sup>
Hjørne (v)	2.970	2.000	1.000	2.810	Aggressiv	2,5 t. kuglehoved løft	5 kN/m <sup>2</sup>
1 meters pas	990	2.000	1.000	990	Aggressiv	2,5 t. kuglehoved løft	5 kN/m <sup>2</sup>
2 meters pas	1.990	2.000	1.000	1.980	Aggressiv	2,5 t. kuglehoved løft	5 kN/m <sup>2</sup>

200L 3d  
Hjørnesamling

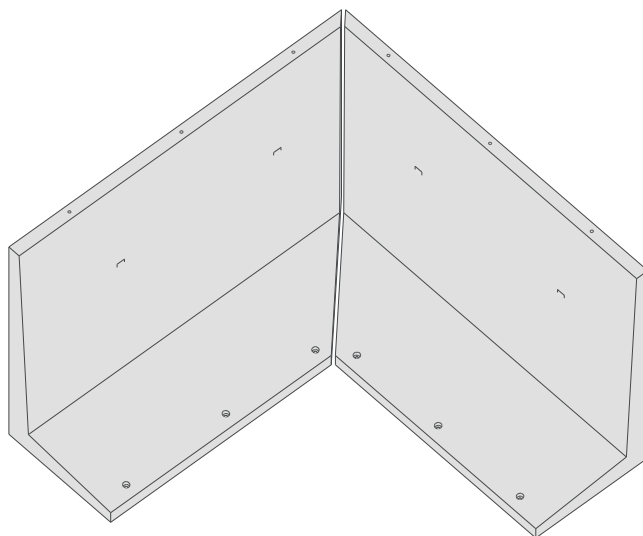

200L Plan  
Hjørnesamling

