

3D

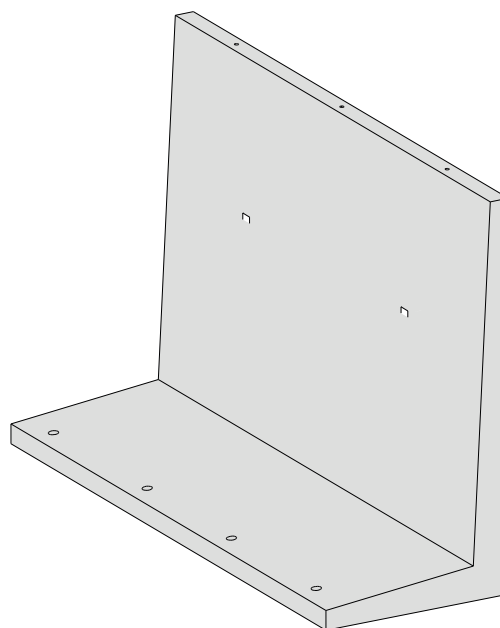

Snit A

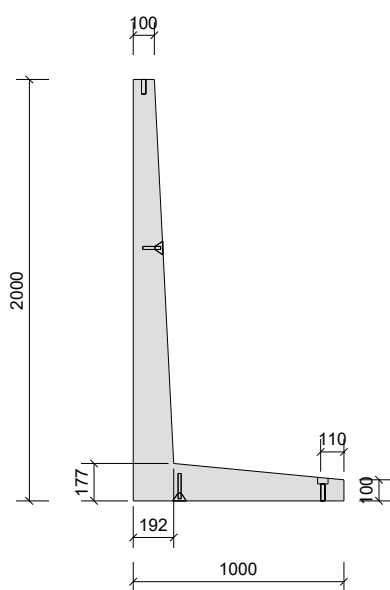

Opstalt

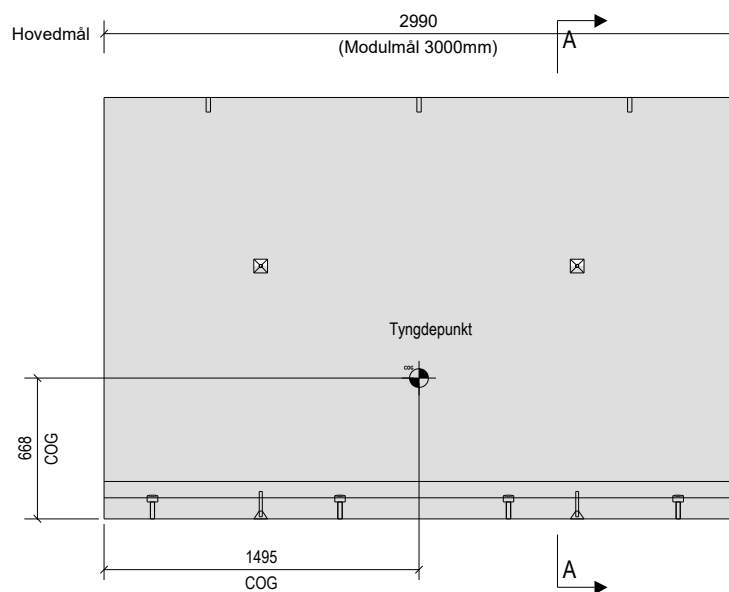

Type	L (mm)	H (mm)	B (mm)	Kg (ca.)	Miljøklasse	Løftegrej	Fladelast
Standard	2.990	1.500	1.000	2.950	Aggressiv	2,5 t. kugle-hoved løft	3,5 kN/m ²
Hjørne (h)	2.970	1.500	1.000		Aggressiv	2,5 t. kugle-hoved løft	3,5 kN/m ²
Hjørne (v)	2.970	1.500	1.000		Aggressiv	2,5 t. kugle-hoved løft	3,5 kN/m ²
1 meters pas	990	1.500	1.000	984	Aggressiv	2,5 t. kugle-hoved løft	3,5 kN/m ²
2 meters pas	1.990	1.500	1.000	1.967	Aggressiv	2,5 t. kugle-hoved løft	3,5 kN/m ²

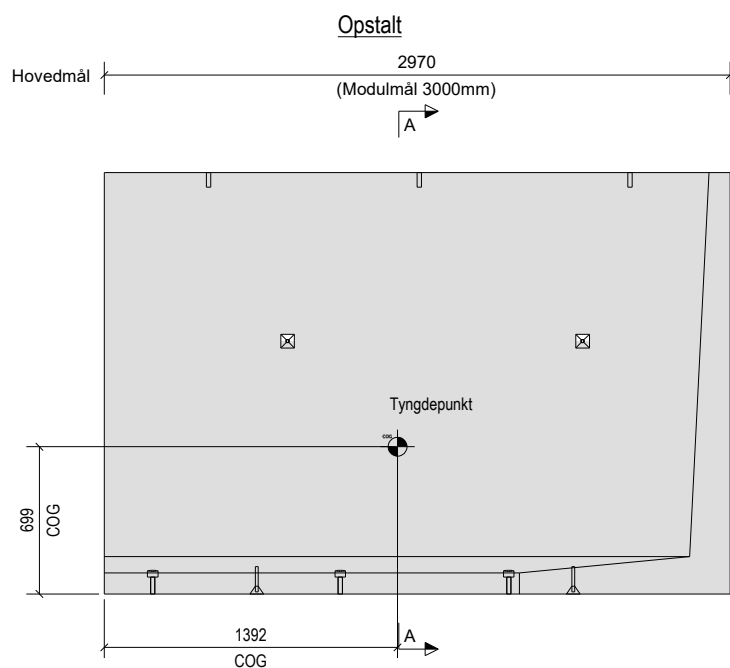
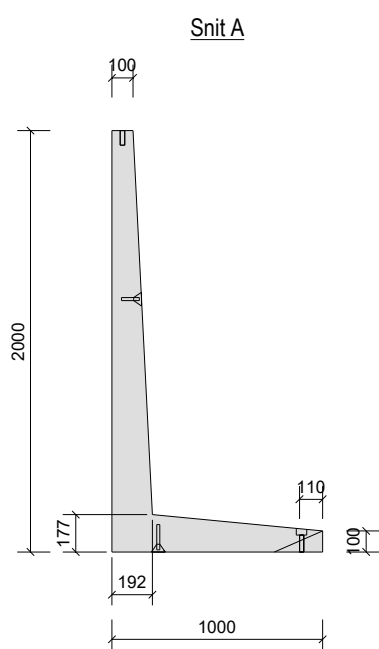
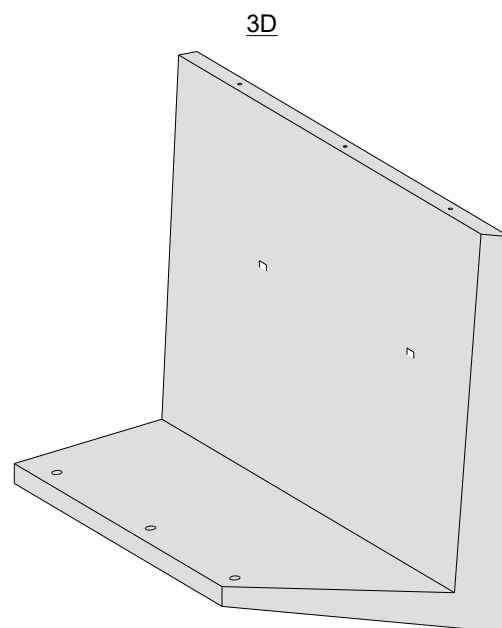

Type	L (mm)	H (mm)	B (mm)	Kg (ca.)	Miljøklasse	Løftegrej	Fladelast
Standard	2.990	1.500	1.000	2.950	Aggressiv	2,5 t. kuglehoved løft	3,5 kN/m ²
Hjørne (h)	2.970	1.500	1.000		Aggressiv	2,5 t. kuglehoved løft	3,5 kN/m ²
Hjørne (v)	2.970	1.500	1.000		Aggressiv	2,5 t. kuglehoved løft	3,5 kN/m ²
1 meters pas	990	1.500	1.000	984	Aggressiv	2,5 t. kuglehoved løft	3,5 kN/m ²
2 meters pas	1.990	1.500	1.000	1.967	Aggressiv	2,5 t. kuglehoved løft	3,5 kN/m ²

3D

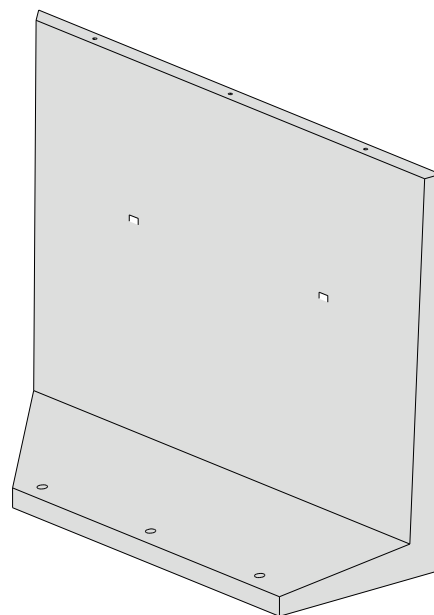

Snit A

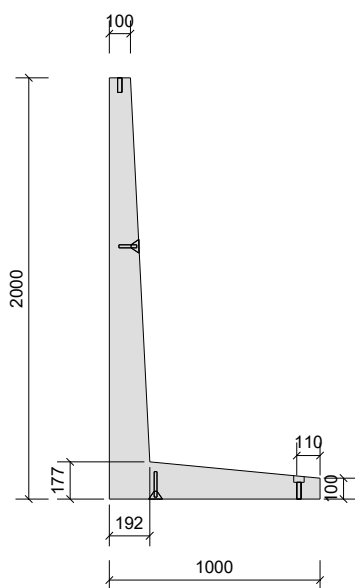

Opstalt

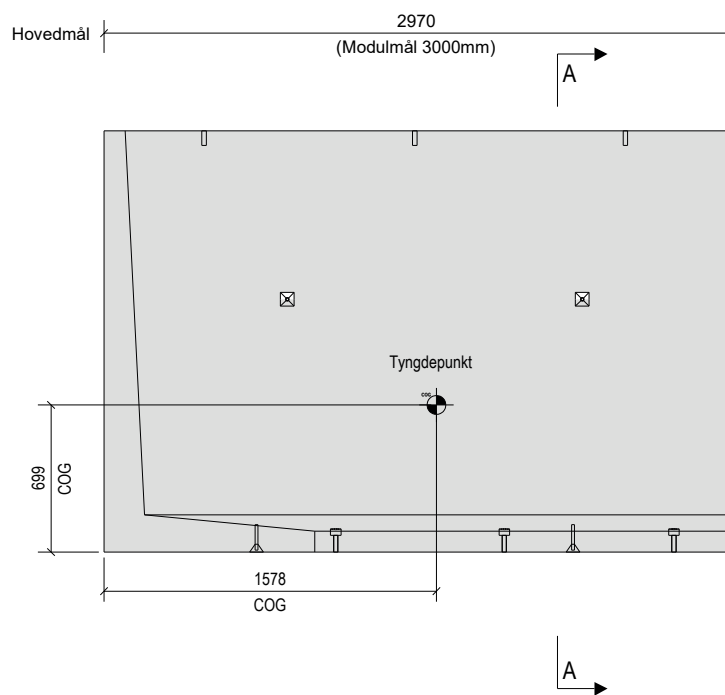

Type	L (mm)	H (mm)	B (mm)	Kg (ca.)	Miljøklasse	Løftegrej	Fladelast
Standard	2.990	1.500	1.000	2.950	Aggressiv	2,5 t. kuglehoved løft	3,5 kN/m ²
Hjørne (h)	2.970	1.500	1.000		Aggressiv	2,5 t. kuglehoved løft	3,5 kN/m ²
Hjørne (v)	2.970	1.500	1.000		Aggressiv	2,5 t. kuglehoved løft	3,5 kN/m ²
1 meters pas	990	1.500	1.000	984	Aggressiv	2,5 t. kuglehoved løft	3,5 kN/m ²
2 meters pas	1.990	1.500	1.000	1.967	Aggressiv	2,5 t. kuglehoved løft	3,5 kN/m ²