

Type	L (mm)	H (mm)	B (mm)	Kg (ca.)	Miljøklasse	Løftegrej	Fladelast
Standard	2.990	2.500	1.200	3.950	Aggressiv	5,0 t. kuglehoved løft	3,5 kN/m ²
Hjørne (h)	2.970	2.500	1.200		Aggressiv	5,0 t. kuglehoved løft	3,5 kN/m ²
Hjørne (v)	2.970	2.500	1.200		Aggressiv	5,0 t. kuglehoved løft	3,5 kN/m ²
1 meters pas	990	2.500	1.200	1.317	Aggressiv	5,0 t. kuglehoved løft	3,5 kN/m ²
2 meters pas	1.990	2.500	1.200	2.634	Aggressiv	5,0 t. kuglehoved løft	3,5 kN/m ²

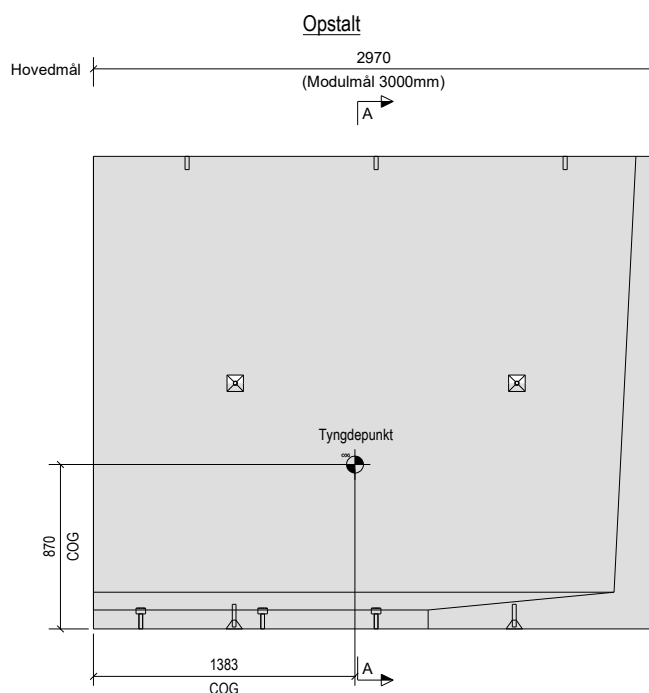

Type	L (mm)	H (mm)	B (mm)	Kg (ca.)	Miljøklasse	Løftegrej	Fladelast
Standard	2.990	2.500	1.200	3.950	Aggressiv	5,0 t. kuglehoved løft	3,5 kN/m ²
Hjørne (h)	2.970	2.500	1.200		Aggressiv	5,0 t. kuglehoved løft	3,5 kN/m ²
Hjørne (v)	2.970	2.500	1.200		Aggressiv	5,0 t. kuglehoved løft	3,5 kN/m ²
1 meters pas	990	2.500	1.200	1.317	Aggressiv	5,0 t. kuglehoved løft	3,5 kN/m ²
2 meters pas	1.990	2.500	1.200	2.634	Aggressiv	5,0 t. kuglehoved løft	3,5 kN/m ²

3D

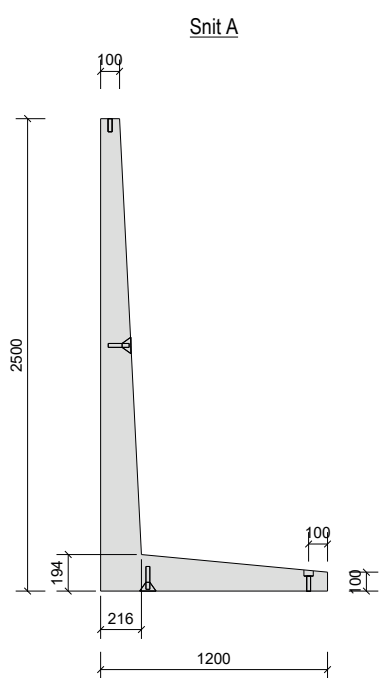
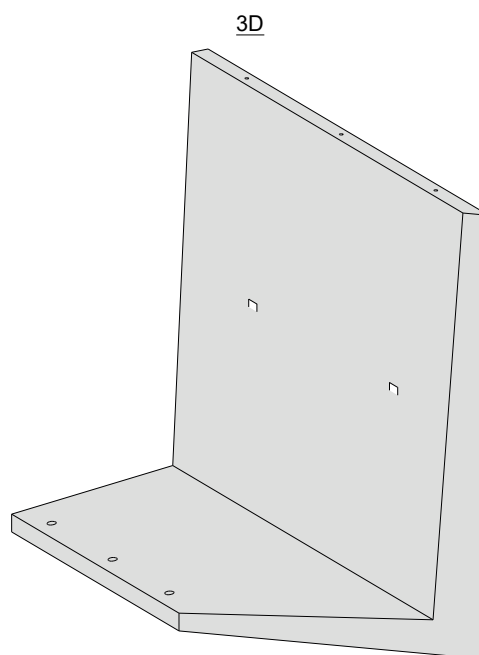
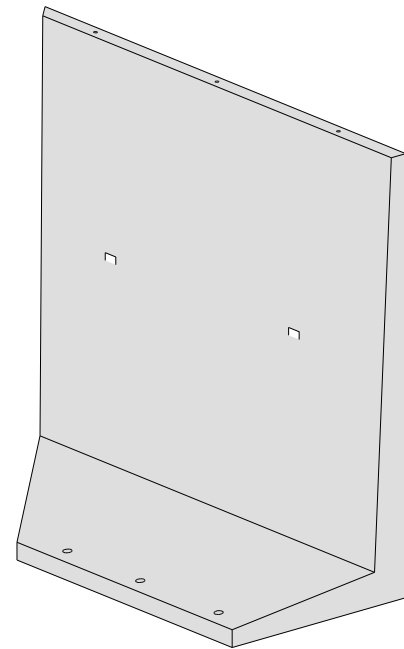

Snit A

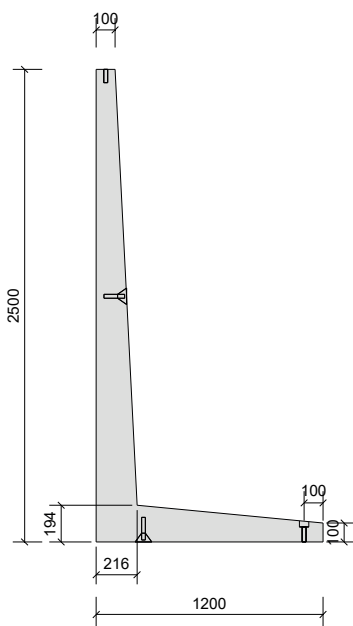

Opstalt

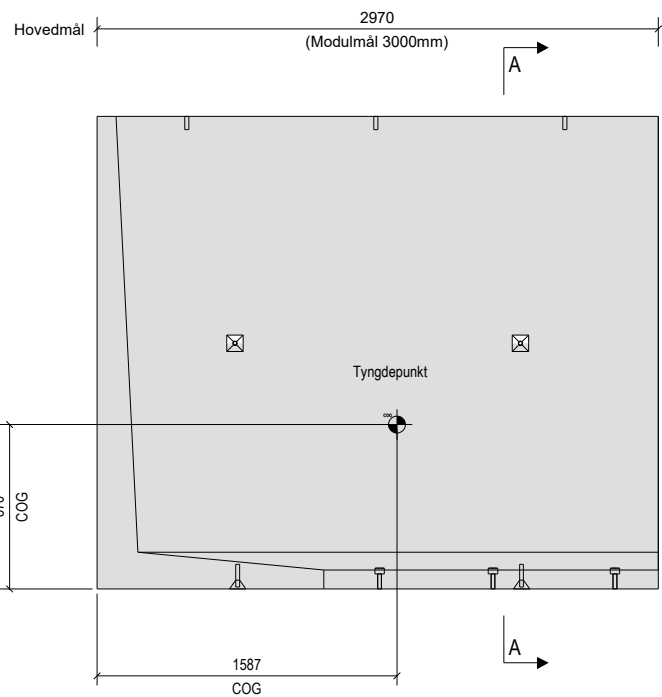

Type	L (mm)	H (mm)	B (mm)	Kg (ca.)	Miljøklasse	Løftegrej	Fladelast
Standard	2.990	2.500	1.200	3.950	Aggressiv	5,0 t. kugle-hoved løft	3,5 kN/m ²
Hjørne (h)	2.970	2.500	1.200		Aggressiv	5,0 t. kugle-hoved løft	3,5 kN/m ²
Hjørne (v)	2.970	2.500	1.200		Aggressiv	5,0 t. kugle-hoved løft	3,5 kN/m ²
1 meters pas	990	2.500	1.200	1.317	Aggressiv	5,0 t. kugle-hoved løft	3,5 kN/m ²
2 meters pas	1.990	2.500	1.200	2.634	Aggressiv	5,0 t. kugle-hoved løft	3,5 kN/m ²