

PERSTRUP - CENTERSØJLE TIL A-DÆK
STR. 10-12 og 13-16 + 26-31 og 17-20 + 26-38

Plan, opstalt og isometri, målestok 1:50

2010

PERSTRUP

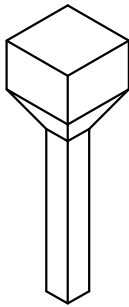

Str. 10-12

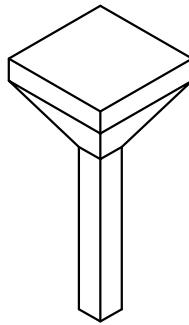

Str. 13-16 +
Str. 26-31

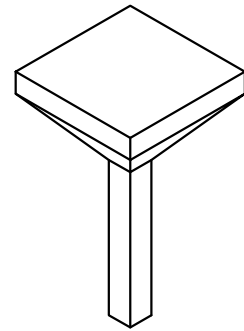

Str. 17-20 +
Str. 32-38

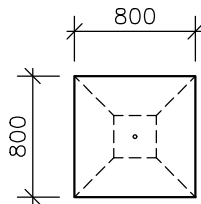

Plan

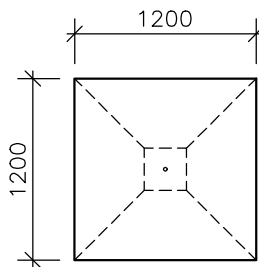
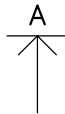

Plan

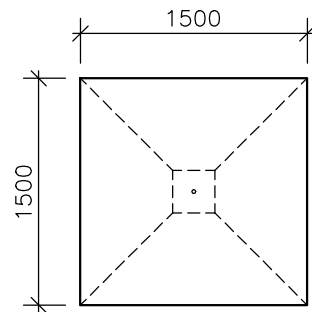

Plan

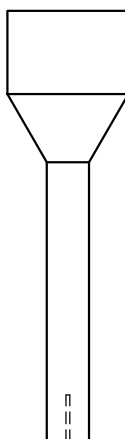

Opstalt A

